

TV INTERFACE

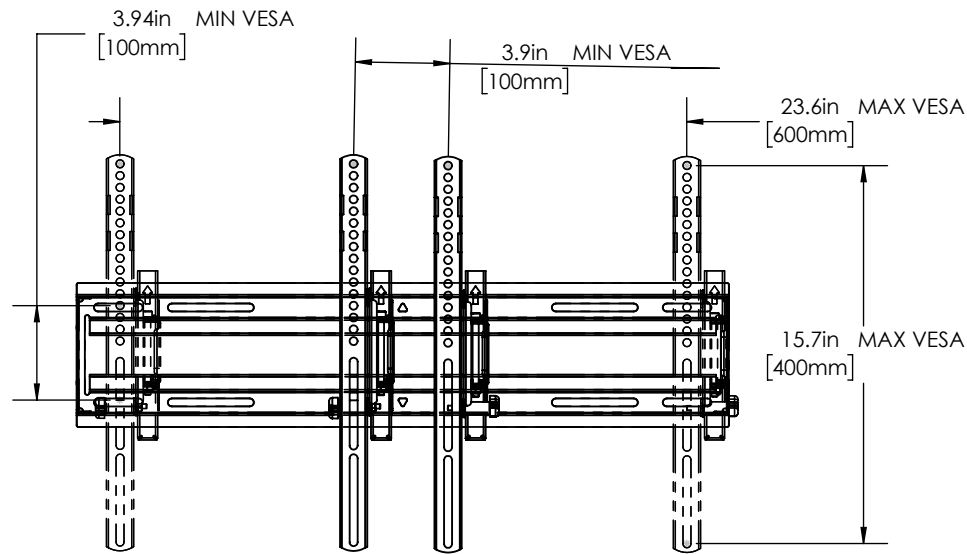

LARGE EXT TILT 5.1" / 2.8" [16"-24"] 6805-002414-XXX

THE INFORMATION AND DESIGNS CONTAINED IN THIS DRAWING ARE CONFIDENTIAL AND THE PROPRIETARY PROPERTY OF LEGRAND | AV. NEITHER THIS DESIGN NOR ANY INFORMATION CONTAINED IN THIS DRAWING MAY BE REPRODUCED OR DISCLOSED TO OTHERS WITHOUT THE EXPRESS WRITTEN CONSENT OF LEGRAND | AV.
本图纸所包含的信息和设计均系 LEGRAND | AV 机密和知识产权。本图纸包含的设计和信息未经 LEGRAND | AV 书面同意均不得复制或 者泄露给他人

3-D

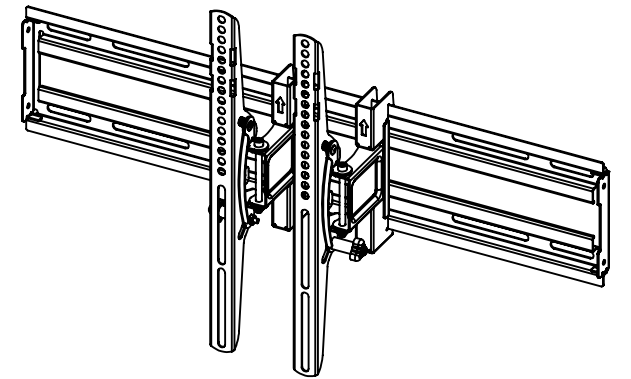

WALL PLATE

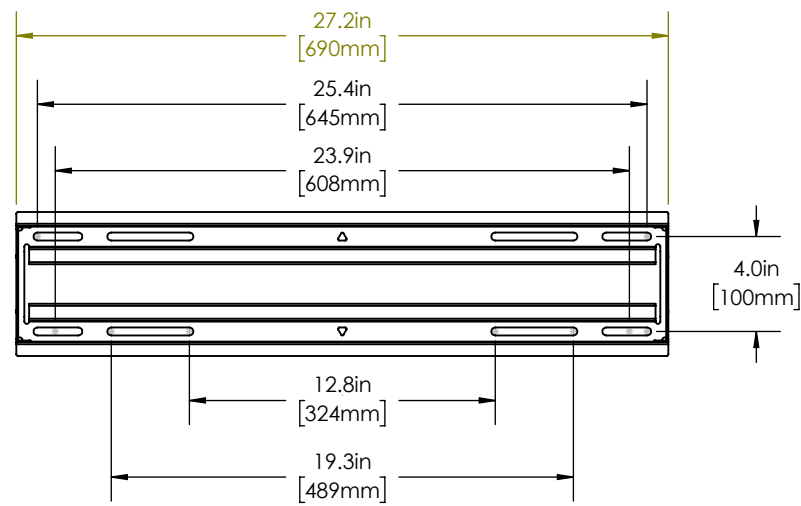

TOP VIEW - EXTENDED

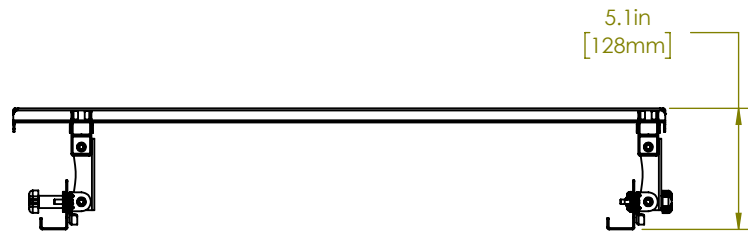

SIDE VIEW - EXTENDED

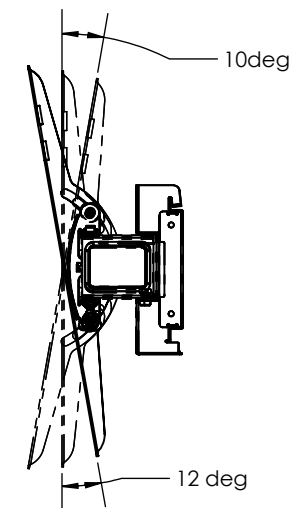

FULLY ASSEMBLED MOUNT

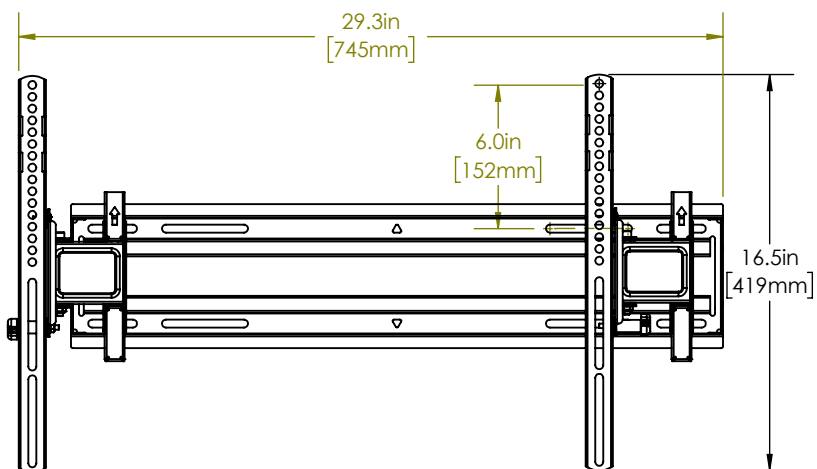

FRONT VIEW - RETRACTED

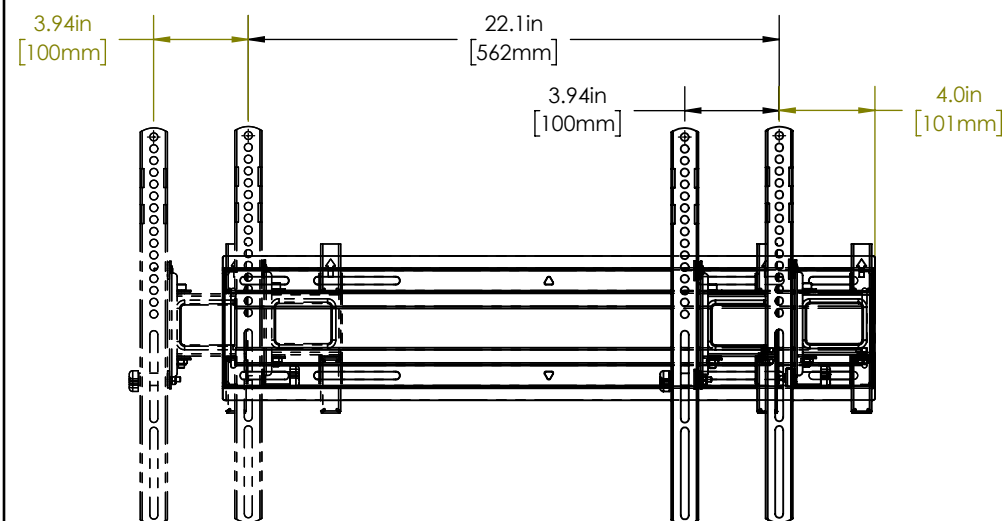

SIDE VIEW RETRACTED

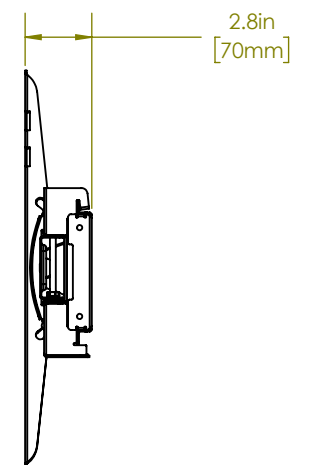

LARGE EXT TILT 5.1" / 2.8" [16"-24"] 6805-002436-XXX

